

UNCONVENTIONAL IDEAS

NIERI

NIERI

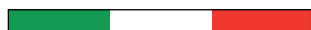

dal 1929

2016

NIERI is a trademark of ROMA IMPERIALE srl

Via Bologna, 13 - 51039 - Quarrata - PT- ITALY
tel: 0039 0573 7733 - fax: 0039 0573 739710

info@romaimperiale.net

www.romaimperiale.net www.nieri.it www.niericountry.it
www.nierifrance.fr www.nieridivani.it



NIERI

MADE IN ITALY



ENGLISH

ITALIANO

DEUTSCH

FRANCAIS

ESPAÑOL

LEGENDA

ARMCHAIR	POLTRONA	SESSEL	FAUTEUIL	BUTACA
2 SEATER	2 POSTI	2 SITZER	2 PLACES	2 PLAZAS
2,5 SEATER	2,5 POSTI	2,5 SITZER	2,5 PLACES	2,5 PLAZAS
2 SEATER RELAX RIGHT/LEFT	2 POSTI RELAX DESTRA/SINISTRA	2 SITZER MIT OTTOMANE RECHTS/LINKS	2 PLACES RELAX DROITE/GAUCHE	2 PLAZAS RELAX DERECHO/IZQUIERDO
3 SEATER	3POSTI	3 SITZER	3 PLACES	3 PLAZAS
3 SEATER WITH MECHANISM	3 POSTI MECC	3 SITZER MIT FUNKTION	3 PLACES MECC	3 PLAZAS MECANISMO
3 SEATER WITH ORTHOPEDIC BED	3 POSTI LETTO ORTOPEDICO	3 SITZER MIT LATTENROSENBETT	3 PLACES LETTO ORTOPEDICO	3 PLAZAS CON CAMA ORTOPEDICO
3 SEATER MAX	3 POSTI MAX	3 SITZER MAX	3 PLACES MAX	3 PLAZAS MAX
3 SEATER MAX WITH CHAISE LONGUE RIGHT/LEFT	3 POSTI MAX RELAX DESTRA/SINISTRA	3 SITZER MAX OTTOMANE RECHTS/LINKS	3 PLACES MAX RELAX DROITE/GAUCHE	3 PLAZAS MAX RELAX DERECHO/IZQUIERDO
3 SEATER MAX WITH MECHANISM	3 POSTI MAX MECC	3 SITZER MAX MIT FUNKTION	3 PLACES MAX MECHANIQUE	3 PLAZAS MAX MECHANIQUE
CENTRAL ELEMENT	ELEMENTO CENTRALE	ZWISCHENELEMENT	ELEMENT CENTRAL	ELEMENTO CENTRAL
CENTRAL ELEMENT 2 SEATER	CENTRALE 2 POSTI	ZWISCHENELEMENT 2 SITZER	ELEMENT CENTRAL 2 PLACES	ELEMENTO CENTRAL 2 PLAZAS
END ELEMENT RIGHT/LEFT	TERMINALE DESTRA/SINISTRA	ENDELEMENT RECHTS/LINKS	TERMINAL DROITE/GAUCHE	TERMINAL DERECHO/IZQUIERDO
END ELEMENT 2 SEATER RIGHT/LEFT	TERMINALE 2 POSTI DESTRA/SINISTRA	ENDELEMENT 2 SITZER RECHTS/LINKS	TERMINAL 2 PLACES DROITE/GAUCHE	TERMINAL 2 PLAZAS DERECHO/IZQUIERDO
END ELEMENT 2 SEATER RELAX RIGHT/LEFT	TERMINALE 2 POSTI RELAX DESTRA/SINISTRA	ENDELEMENT 2 SITZER OTTOMANE RECHTS/LINKS	TERMINAL 2 PLACES RELAX DROITE/GAUCHE	TERMINAL 2 PLAZAS RELAX DERECHO/IZQUIERDO
END ELEMENT 2 SEATER MOVABLE BACK	TERMINALE 2 POSTI SPALLIERA MECCANICA	ENDELEMENT 2 SITZER SPALLIERA MECCANICA	TERMINAL 2 PLACES DOSSIER AMOVIBLE	TERMINAL 2 PLAZAS CON MECANISMO
END ELEMENT 2 SEATER MOVABLE ARMREST	TERMINALE 2 POSTI BRACCIOLO MOVIBILE	ENDELEMENT 2 SITZER BRACCIOLO MOVIBILE	TERMINAL 2 PLACES ACCOUDOIR MOVIBILE	TERMINAL 2 PLAZAS APOYABRATOS MOVIBILE
END ELEMENT 2 SEATER WITH ORTHOPEDIC BED	TERMINALE 2 POSTI LETTO DESTRA/SINISTRA	ENDELEMENT 2 SITZER LETTO RECHTS/LINKS	TERMINAL 2 PLACES LIT DROITE/GAUCHE	TERMINAL 2 PLAZAS CAMA DERECHO/IZQUIERDO
END ELEMENT RIGHT/LEFT SPEC. 45DEGR.	TERMINALE DX/SX 45°	ENDELEMENT RECHTS/LINKS 45°	TERMINAL DROITE/GAUCHE 45°	TERMINAL DROITE/GAUCHE 45°
END ELEMENT 3 SEATER RIGHT/LEFT	TERMINALE 3 POSTI DESTRA/SINISTRA	ENDELEMENT 3 SITZER RECHTS/LINKS	TERMINAL 3 PLACES DROITE/GAUCHE	TERMINAL 3 PLAZAS DERECHO/IZQUIERDO
END ELEMENT 3 SEATER RIGHT/LEFT WITH ORTHOPEDIC BED	TERMINALE 3 POSTI DESTRA/SINISTRA LETTO ORTOPEDICO	ENDELEMENT 3 SITZER RECHTS/LINKS MIT LATTENROSENBETT	TERMINAL 3 PLACES DROITE/GAUCHE LIT	TERMINAL 3 PLAZAS DERECHO/IZQUIERDO CAMA
CHAISE LONGUE RIGHT/LEFT	CHAISE LONGUE DESTRA/SINISTRA	REKAMIERE RECHTS/LINKS	CHAISE LONGUE DROITE/GAUCHE	CHAISE LONGUE DERECHO/IZQUIERDO
CHAISE LONGUE RIGHT/LEFT WITH HEADREST	CHAISE LONGUE DESTRA/SINISTRA POGGIATESTA	REKAMIERE RECHTS/LINKS KOPFSTUETZE	CHAISE LONGUE DROITE/GAUCHE APPUIS TETE	CHAISE LONGUE DERECHO/IZQUIERDO APOYACABEZA CHAISE
CHAISE LONGUE SQUARED RIGHT/LEFT	CHAISE LONGUE SQUADRATA DESTRA/SINISTRA	REKAMIERE CARIERT RECHTS/LINKS	CHAISE LONGUE CARRÉ DROITE/GAUCHE	LONGUE CONTENEDOR DERECHO/IZQUIERDO
PENINSULA RIGHT/LEFT	PENISOLA DESTRA/SINISTRA	PENINSEL RECHTS/LINKS	ILE DROITE/GAUCHE	PENINSULA DROITE/GAUCHE
CORNER	ANGOLO	ECKE	ANGLE	RINCON
SOUND CORNER	ANGOLO SOUND	ECKE SOUND	ANGLE SOUND	RINCON SOUND
CENTRAL SOUND STORAGE	CONTENITORE CENTRALE SOUND	ZWISCHENELEMENT SOUND MIT BEHAELTER	COFFRE ELEMENT CENTRAL SOUND	CONTENEDOR ELEMENTO CENTRAL SOUND
CORNER/TABLE	TAVOLO CORNER	TISCH/ECKE	ANGLE/TABLE	RINCON/MESA
CORNER NAPOLEON	ANGOLO NAPOLEON	NAPOLEON ECKE	ANGLE NAPOLEON	RINCON NAPOLEON
ROUND CORNER	ANGOLO ROUND	RUNDE ECKE	ANGLE ROUND	RINCON ROUND
MANUAL RECLINER	POLTRONA MECC MANUALE	TV SESSEL MANUELLE	FAUTEIL RECLINER MANUELLE	BUTACA RELAX CON FUNCION MANUAL
SOFABED	DIVANO LETTO	SOFABETT	RAPIDO	SOFACAMA
ORTHOPEDIC BED	LETTO ORTOPEDICO	LATTENROSENBETT	LIT	CAMA
ROLL CHAIR	POLTRONA ROLL	ROLL SESSEL	FAUTEIL PIVOTANT	BUTACA CON GIRATORIO
ROLL CHAIR WITH MECHANISM	POLTRONA ROLL MECCANISMO	ROLL SESSEL MIT FUNKTION	FAUTEIL ROLL MECANIQUE	BUTACA CON GIRATORIO Y MECANISMO
ROUND SEAT XXL	ROUND SEAT XXL	ROUND SEAT XXL	ROUND SEAT XXL	ROUND SEAT XXL
FOOTSTOOL	POUF	HOCKER	POUF	POUF
FOOTSTOOL RIGHT /LEFT	POUF DESTRA/SINISTRA	HOCKER RECHTS/LINKS	POUF DROITE/GAUCHE	POUF DERECHO/IZQUIERDO
FOOTSTOOL MAX	POUF MAX	HOCKER MAX	POUF MAX	POUF MAX
DROP SHAPED FOOTSTOOL	POUF GOCCIA	HOCKER GOCCIA	POUF GOCCIA	POUF GOCCIA
CASE/ FOOTSTOOL	POUF CONTENITORE	HOCKER MIT BEHAELTER	POUF COFFRE	POUF CONTENEDOR
BACK CUSHIONS	CUSCINO SPALLIERA	RUECKEN KISSEN	COUSSIN DE DOSSIER	COJIN DE RESPALDO
HELP LUMBAR CUSHION	CUSCINO POGGIARENI	NIEREN KISSEN	COUSSIN CALEREIN	COJIN HELP
PILLOW 45X45	CUSCINO 45X45	KISSEN 45X45	COUSSIN 45X45	COJIN 45X45
HEADREST	POGGIATESTA	KOPFSTUETZE	APPUYE TETE	APOYACABEZA
RECTANGULAR TABLE	TAVOLO RETTANGOLARE	TISCH RECHTECKIG	TABLE RECTANGULAIRE	MESA RECTANGULAR
ROUND TABLE	TAVOLO TONDO	RUND TISCH	TABLE RONDE	TABLE REDONDA
OVAL TABLE	TAVOLO OVALE	OVAL TISCH	TABLE OVAL	TABLE OVAL
SIDE TABLE	TAVOLO LATERALE	BEISTELL TISCH	TABLE LATERAL	TABLE LATERAL

INTRODUCTION

*CLASSICAL COLLECTION

- 12 _Bentley
- 16 _Chester
- 18 _Corniche
- 22 _Elena
- 24 _Incas
- 28 _Leonardo
- 32 _Palatino
- 34 _Pavarotti
- 36 _Planet & _Mars
- 40 _Pompei
- 42 _Romeo & _Zeno
- 44 _Victoria

ARM+CHAIRS

- 48 _Diletta
- 49 _Marlene
- 50 _My Chair

FOOTSTOOLS & TABLES 53

DECORS 57

GENERAL SALES CONDITIONS AND TECHNICAL SPECIFICATIONS 60

NOVABUK FURNITURE AND FABRIC FURNITURE 62

MUN CERTIFICATION OF 100% MADE IN ITALY 66

CONTACTS 70



COMPANY WITH MANAGEMENT SYSTEM
ITCOT.MUN NATIONAL MANUFACTURING
= MARCHIO UNICO NAZIONALE =

* FOR NIERI'S MODERN COLLECTION PLEASE ASK FOR THE CATALOGUE

INTRODUCTION

ABOUT US_ A BIT OF HISTORY

The headquarter of Roma Imperiale srl, the young company which distributes the long known brand Nieri, is in Quarrata in the heart of Tuscany: a land of art and beauty.

Born from the passion and creativity of Alberto Nieri, the third generation after the founder Gino, the brand Nieri is now a reality of global significance for the number of exports and for the undisputed quality of its lounges. The company is currently managed by the fourth generation of the Nieri's family, being as a matter of fact a Family Business since 1929. Rarely indeed the story of a company, is identified so closely with the story of a family such as for Nieri.

With the work of generations Nieri's Family has built, from nothing, a production which today has an international feel.

The production units are concentrated where the technical, administrative and commercial control unit is located, that is, all in Tuscany. All materials such as leather, fabric, wood and rubber come from Tuscany or the north of Italy.



Together with flair for style and details but also attention to the production, Nieri uses a total quality system according to international standards and it's certified by MUN as National Manufacturer, a certificate that guarantees that the origin of all products is 100% Made in Italy. The MUN Registration number for Nieri is ITCOT.MUN-A0000016

Nieri is nowadays exporting in over 62 countries in the world its high quality sofas and armchairs, all made with the best design and the best Italian style.



Historical facts:

1929 the grandfather Gino, a young carpenter who is distinguished by excellent technical skills and for his original creations, began creating wooden structures for upholstered furniture.

Learned the art of making chairs and sofas, Gino started designing and manufacturing the pieces of furniture entirely on his own and managed to create exclusive furniture as for originality, quality and style.

In the 50s, his son, Mauro Nieri contributed to the expansion of the company with new energy and fresh ideas on the Italian market. In this way the tradition passed into the hands of the second generation.

In the 70ies Mauro was joined, already at an early age, by his son Alberto, who also participates in the company's development also on the international scene by taking part in the most important trade fairs and exhibitions Worldwide, therefore increasing the company's export level.

In recent years Alberto received the help of his brother Maurizio, his daughter Jessica and his cousin Susanna whose managerial professionalism is expressed in remarkable successes in new markets and new channels, carefully chosen and managed.

Today at the fourth generation, the company is still carried out by the Nieri Family which with new globalized projects and opened towards a younger audience is increasingly entering large and diverse market segments.

The design Nieri is a process that involves love of form, comfort, quality. Each approved design is the result of careful studies and long analysis.

The production cycle begins with the cutting and the stitching of leather and fabrics, all swatches carefully and strictly selected.



Once processed, the wooden frames are elegantly handled by master painters and collected in the various production centers for the assembly. Meanwhile, upholsterers create stuffing pillows and backrests with a technology and an attention that can only be appreciated by sitting on an exclusive sofa Nieri.

Industrial production is combined with the craft technique so that the product obtained is unique and comparable to a true work of art. Upholsterers and assemblers create one by one the pieces of furniture combining leather, fabrics and rubber, taking care centimeter by centimeter of every detail, giving shape, beauty and harmony to the composition.

The result: a "unique piece" designed and studied in detail.

Even the packaging, distinguishes the company from the "other" for attention, protection and safety: a Nieri Sofa deserves every care!

CLASSICAL COLLECTION





CLASSICAL
COLLECTION



_Bentley

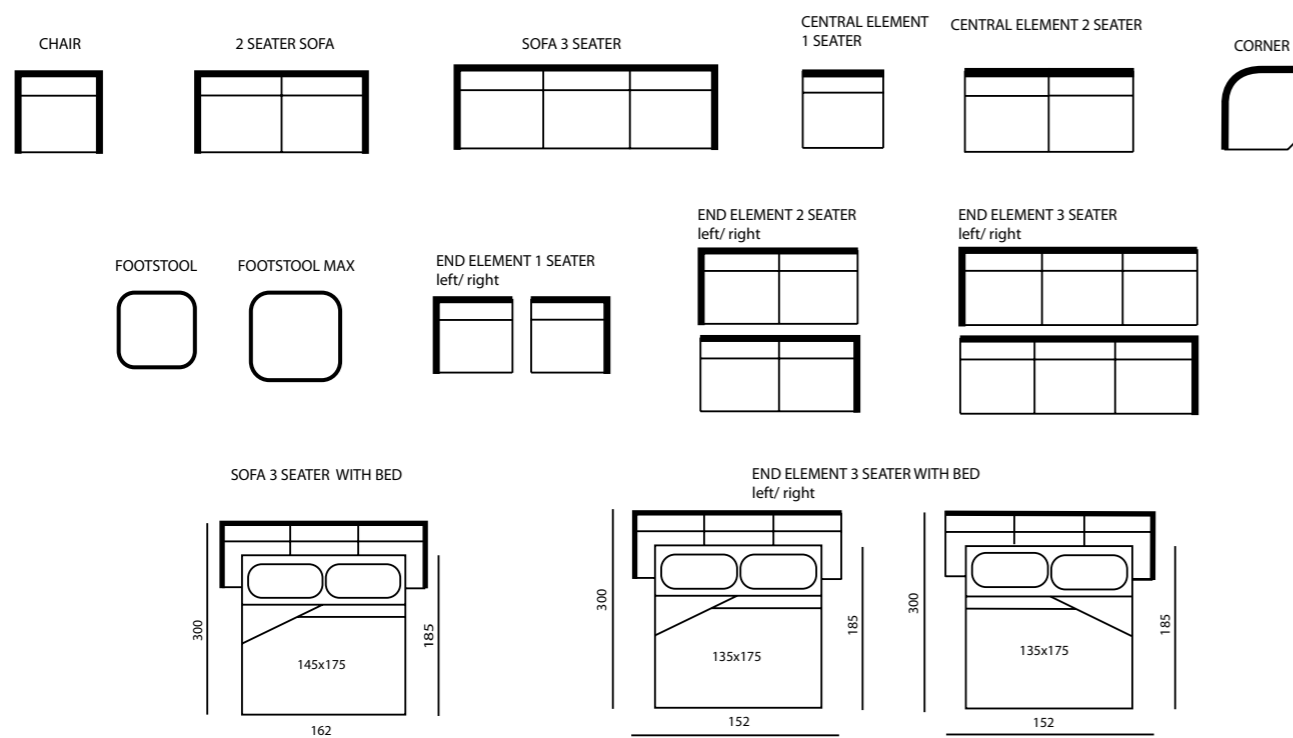

ELEMENTS

	H	L	D	V	W
BENTLEY ARMCHAIR	90	117	105	1,10	33
BENTLEY SOFA 2 SEATER	90	172	105	1,65	48
BENTLEY SOFA 3 SEATER	90	232	105	2,20	60
BENTLEY CENTRAL ELEMENT 1 SEATER	90	60	105	0,60	16
BENTLEY END ELEMENT 1 SEATER	90	120	105	1,20	28
BENTLEY CENTRAL ELEMENT 2 SEATER	90	86	105	0,90	19
BENTLEY END ELEMENT 2 SEATER	90	146	105	1,40	40
BENTLEY END ELEMENT 3 SEATER	90	206	105	2,00	50
BENTLEY CORNER	90	118	105	1,10	35
BENTLEY FOOTSTOOL	40	60	60	0,10	10
BENTLEY FOOTSTOOL MAX	42	80	60	0,20	13

- * On request Help cushion for lumbar support.
- * The height of the legs bed version is 6 cm higher so that there will be a height differences with the normal armchairs even if ordered together.
- * The version with bed shows slight differences in the external aspect and the seat comfort. There is a visible front covering under the bottom frame in order to cover the mattress from the external sight. Please ask for any other technical information.
- * Different combinations of coverings or different sizes are not previewed in our system. Special requests, if possible, will be considered a "Not standard production" and a 10% surcharge will be applied.
- * Light padding piece of furniture (please see sales conditions).
- * Back, seat and armrest cushions removable and changeable.



CLASSICAL COLLECTION

_Chester

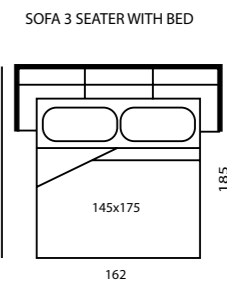
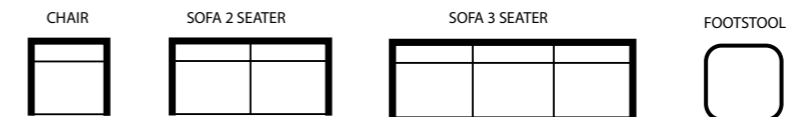

ELEMENTS	H	L	D	V	W
CHESTER ARMCHAIR	78	110	90	0,70	34
CHESTER SOFA 2 SEATER	78	165	90	1,20	44
CHESTER SOFA 3 SEATER	78	220	90	1,60	55
CHESTER FOOTSTOOL	46	58	68	0,20	10

- * Chesterfield working only available with leather coverings.
- * Available in all finishing except briarwood, macassar, zebrano and wengè.
- * An extra 10% on the price has to be added by any non standard modification of the external sight.
- * Seat cushion removable and changeable.
- * Different combinations of coverings or different sizes are not previewed in our system. Special requests, if possible, will be considered a "Not standard production" and a 10% surcharge will be applied.



CLASSICAL
COLLECTION

_Corniche



_Corniche

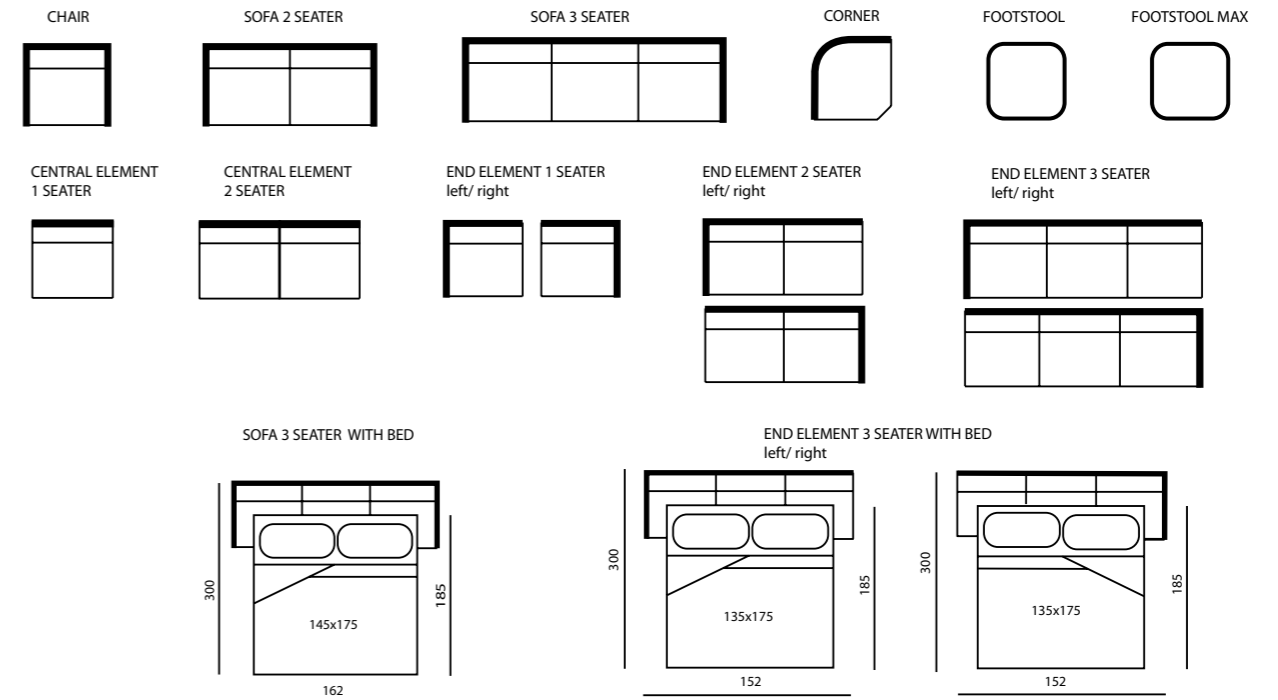

ELEMENTS

	H	L	D	V	W
CORNICHE ARMCHAIR	90	117	105	1,10	33
CORNICHE SOFA 2 SEATER	90	172	105	1,60	48
CORNICHE SOFA 3 SEATER	90	232	105	2,20	60
CORNICHE END ELEMENT 1 SEATER	90	86	105	0,90	19
CORNICHE CENTRAL ELEMENT 1 SEATER	90	60	105	0,60	16
CORNICHE END ELEMENT 2 SEATER	90	146	105	1,40	40
CORNICHE CENTRAL ELEMENT 2 SEATER	90	120	105	1,10	28
CORNICHE END ELEMENT 3 SEATER	90	206	105	2,00	50
CORNICHE FOOTSTOOL MAX	42	80	60	0,20	13
CORNICHE CORNER	90	118	105	1,10	35
CORNICHE FOOTSTOOL	40	60	60	0,10	10

- * Standard wood is briarwood. It is possible to choose other wood finishings of our collection or of RAL color with a surcharge. Ask in advanced before selling.
- * On request Help cushion for lumbar support.
- * The height of the legs bed version is 6 cm higher so that there will be a height differences with the normal armchairs even if ordered together.
- * The version with bed shows slight differences in the external aspect and the seat comfort. There is a visible front covering under the bottom frame in order to cover the mattress from the external sight. Please ask for any other technical information.
- * An extra 10% on the price has to be added by any non standard modification of the external sight.
- * Light padding piece of furniture (please see sales conditions).
- * Back, seat and armrest cushions removable and changeable.
- * Different combinations of coverings or different sizes are not previewed in our system. Special requests, if possible, will be considered a "Not standard production" and a 10% surcharge will be applied.



CLASSICAL
COLLECTION

_Elena

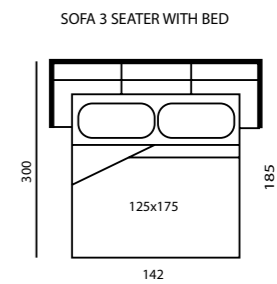

ELEMENTS	H	L	D	V	W
ELENA ARMCHAIR	102	96	85	0,90	20
ELENA SOFA 2 SEATER	102	135	96	1,30	50
ELENA SOFA 3 SEATER	102	185	96	1,80	60
ELENA FOOTSTOOL	40	60	60	0,20	10

- * Available in all finishing of our collection except real briarwood
- * Different combinations of coverings or different sizes are not previewed in our system. Special requests, if possible, will be considered a "Not standard production" and a 10% surcharge will be applied.
- * Light padding piece of furniture (please see sales conditions)
- * Seat cushion removable and changeable.



CLASSICAL
COLLECTION

_Incas



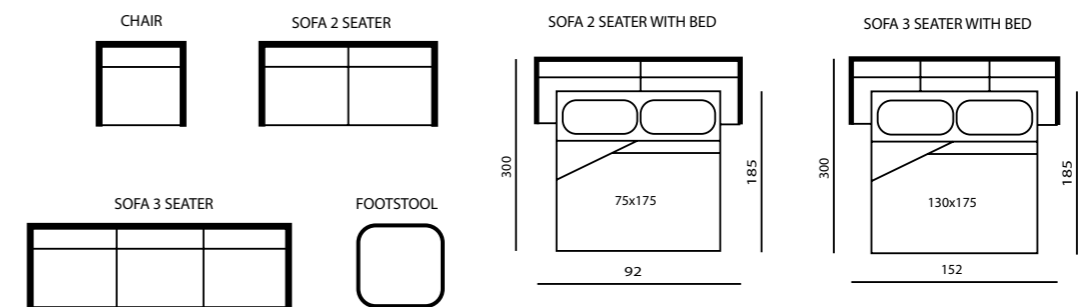

ELEMENTS	H	L	D	V	W
INCAS ARMCHAIR	94	92	96	0,85	22
INCAS SOFA 2 SEATER	94	145	96	1,30	33
INCAS SOFA 3 SEATER	94	198	96	1,80	44
INCAS FOOTSTOOL	40	60	60	0,10	12

- * Available in all finishing of our collection except real briarwood
- * Different combinations of coverings or different sizes are not previewed in our system. Special requests, if possible, will be considered a "Not standard production" and a 10% surcharge will be applied.
- * Light padding piece of furniture (please see sales conditions)
- * Seat cushion removable and changeable.



CLASSICAL
COLLECTION

_Leonardo



3 Seater

Roll Chair

3 Seater

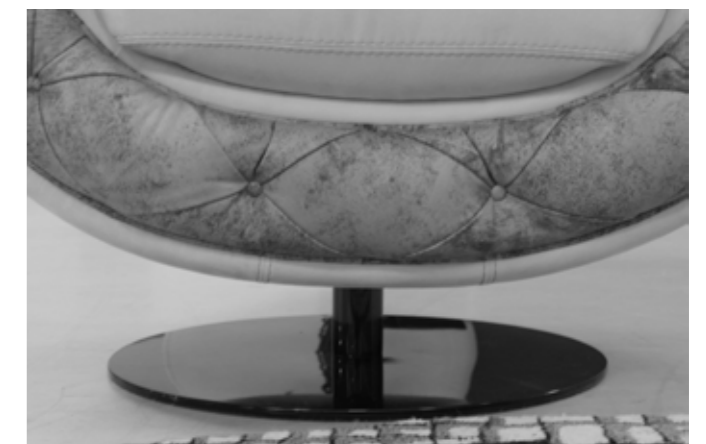

ROLL CHAIR

SOFA 2 SEATER

SOFA 3 SEATER

SOFA 4 SEATER

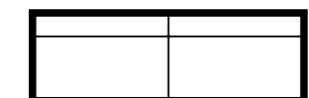
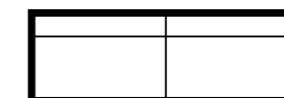
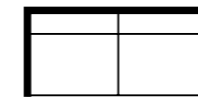

ELEMENTS

ELEMENTS	H	L	D	V	W
LEONARDO ARMCHAIR ROLL	75	100	110	0,80	48
LEONARDO SOFA 2 SEATER	73	190	108	1,50	44
LEONARDO SOFA 3 SEATER	73	235	108	1,85	54
LEONARDO SOFA 4 SEATER	73	280	108	2,20	64

- * The 2 seater comes by default with 4 backcushions, the 3 seater with 5, and the 4 seater with 6.
- * The sofa's legs are made in metal and plastic and are screwed in beneath the sofa and not visible.
- * The Cushions dimentions of each version is available at the botton of the catalogue in the Decors session.
- * Different combinations of coverings or different sizes are not previewed in our system. Special requests, if possible, will be considered a "Not standard production" and a 10% surcharge will be applied.



CLASSICAL
COLLECTION

_Palatino





_Palatino

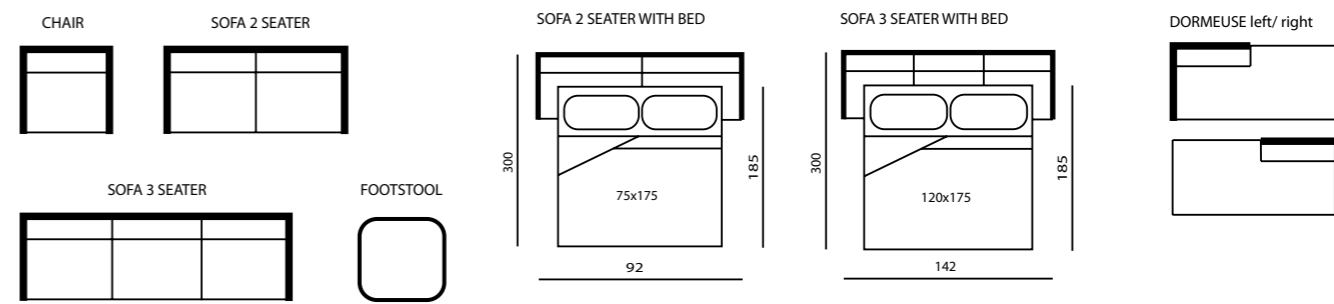

ELEMENTS

	H	L	D	V	W
PALATINO ARMCHAIR	96	100	97	1,00	26
PALATINO SOFA 2 SEATER	96	153	97	1,42	35
PALATINO SOFA 3 SEATER	96	193	97	1,80	43
PALATINO CHAISE LONGUE	78	188	88	1,30	39
PALATINO FOOTSTOOL	45	58	58	0,45	14

- * Available in all finishing of our collection except real briarwood
- * Different combinations of coverings or different sizes are not previewed in our system. Special requests, if possible, will be considered a "Not standard production" and a 10% surcharge will be applied.
- * Light padding piece of furniture (please see sales conditions)
- * Seat cushion removable and changeable.



CLASSICAL COLLECTION

_Pavarotti

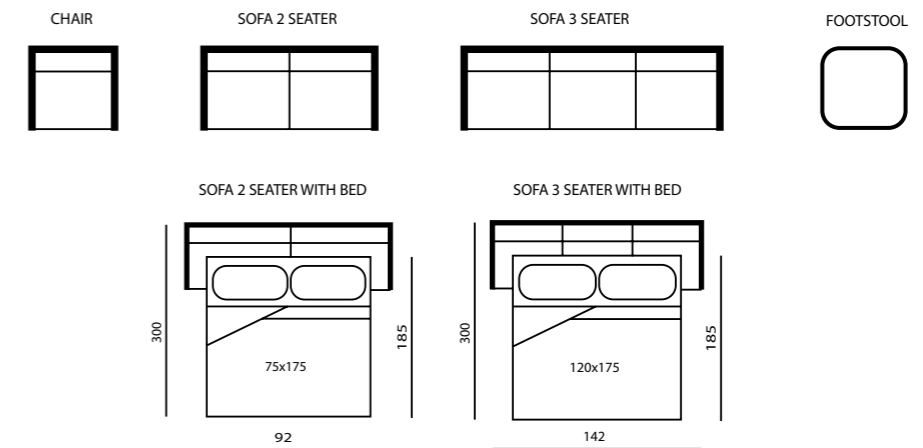

ELEMENTS	H	L	D	V	W
PAVAROTTI ARMCHAIR	96	97	95	0,90	22
PAVAROTTI SOFA 2 SEATER	96	150	95	1,30	33
PAVAROTTI SOFA 3 SEATER	96	190	95	1,70	44
PAVAROTTI FOOTSTOOL	45	58	58	0,15	12

- * Available in all finishing of our collection except real briarwood
- * Different combinations of coverings or different sizes are not previewed in our system. Special requests, if possibile, will be considered a "Not standard production" and a 10% surcharge will be applied.
- * Light padding piece of furniture (please see sales conditions)
- * Seat cushion removable and changeable.



CLASSICAL
COLLECTION

_Planet



_Planet



_Mars

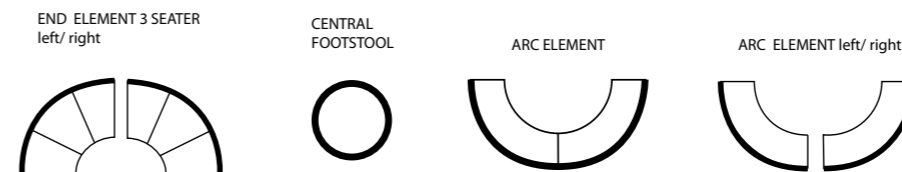

ELEMENTS	H	L	D	V	W
PLANET END ELEMENT 3 SEATER	100	141	190	2,68	46
PLANET ARC ELEMENT	46	240	102	1,15	30
PLANET ARC ELEMENT LEFT/RIGHT	46	120	102	0,60	20
PLANET CENTRAL FOOTSTOOL	46	136	113	0,70	42

- * Available also a modern version with leather covered base and aluminium base profile. In that case the model is called MARS.
- * Available in all finishing of our collection except real briarwood.
- * Light padding piece of furniture (please see sales conditions).
- * Different combinations of coverings or different sizes are not previewed in our system. Special requests, if possible, will be considered a "Not standard production" and a 10% surcharge will be applied.



CLASSICAL COLLECTION

_Pompei

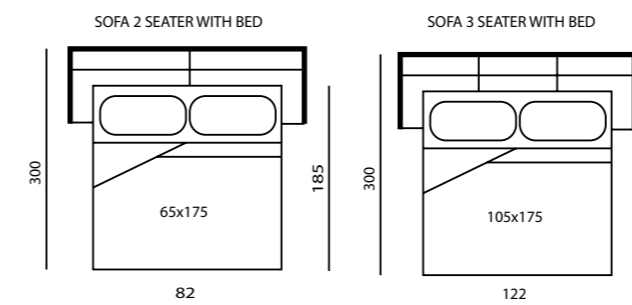
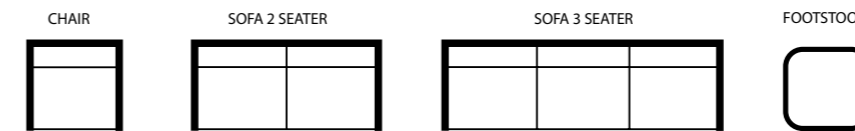

CODES	ELEMENTS	H	L	D	V	W
PMPA01	POMPEI ARMCHAIR	95	103	95	0,95	24
PMPB01	POMPEI SOFA 2 SEATER	95	150	95	1,35	35
PMPC01	POMPEI SOFA 3 SEATER	95	200	95	1,80	45
PMPD01	POMPEI FOOTSTOOL	48	56	56	0,15	12

- * Available in all finishing of our collection except real briarwood
- * Different combinations of coverings or different sizes are not previewed in our system. Special requests, if possible, will be considered a "Not standard production" and a 10% surcharge will be applied.
- * Light padding piece of furniture (please see sales conditions)
- * Seat cushion removable and changeable.



CLASSICAL
COLLECTION

_Zeno



_Romeo

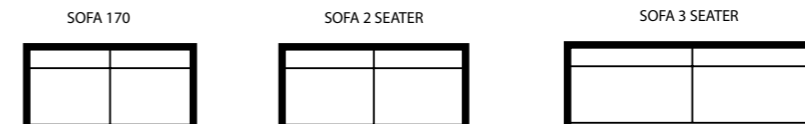

ELEMENTS	H	L	D	V	W
ROMEO / ZENO SOFA 2 SEATER	74/82	190	96	1,50	44
ROMEO / ZENO SOFA 3 SEATER	74/82	230	96	1,80	54
ZENO SOFA SOFA 170	82	170	96	1,40	40

- * When ordered in leather and fabric the backseat part in chester can only be realized in leather and will always be on the right side. Only seat cushions and the plain left side of the backseat can be realized in fabric.
- * Available in all finishing of our collection except real briarwood. Picture finishing is GOLM.
- * Different combinations of coverings or different sizes are not previewed in our system. Special requests, if possible, will be considered a "Not standard production" and a 10% surcharge will be applied.
- * Light padding piece of furniture (please see sales conditions)
- * Seat cushion removable and changeable.



CLASSICAL COLLECTION

_Victoria

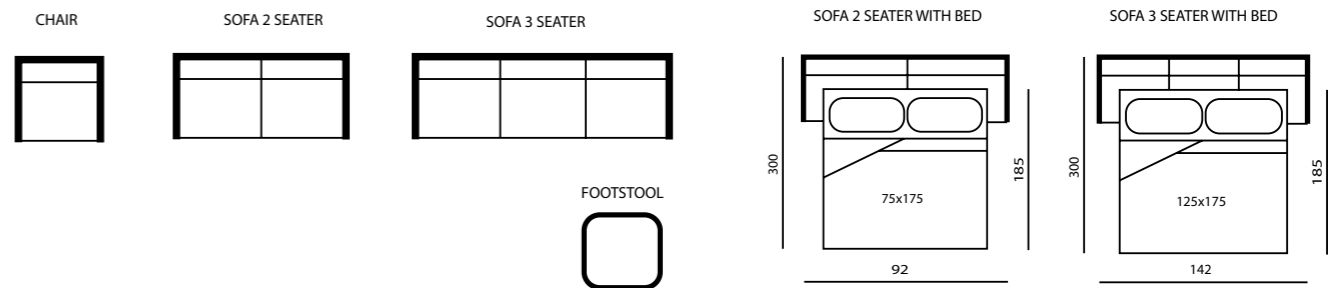

ELEMENTS	H	L	D	V	W
VICTORIA ARMCHAIR	92	95	98	0,86	22
VICTORIA SOFA 2 SEATER	92	145	98	1,31	32
VICTORIA SOFA 3 SEATER	92	195	98	1,76	42
VICTORIA FOOTSTOOL	44	54	54	0,20	12

- * Available in all finishing of our collection except real briarwood
- * Different combinations of coverings or different sizes are not previewed in our system. Special requests, if possible, will be considered a "Not standard production" and a 10% surcharge will be applied.
- * Light padding piece of furniture (please see sales conditions)
- * Seat cushion removable and changeable.

ARM+CHAIRS





ARM+CHAIRS

_Diletta



CHAIR



ELEMENTS

	H	L	D	V	W
DILETTA CHAIR	81	74	64	0,40	12

_Marlene



CHAIR

SOFA 2 SEATER

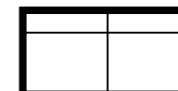

ELEMENTS

	H	L	D	V	W
MARLENE CHAIR	92	62	67	0,40	13
MARLENE 2 SOFA	92	124	67	0,80	26



ARM+CHAIRS

_My Chair



CHAIR FOOTSTOOL



ELEMENTS

	H	L	D	V	W
MY CHAIR CHAIR	101	98	98	0,95	33
MY CHAIR FOOTSTOOL	46	60	58	0,15	11

- * Chesterfield work can be done with leather buttons or swarovski crystals.
- * Legs can be polished in metal color or can be in metal under request.
- * The Side Metal Plate can be left empty or engraved with any name, number or writing under request. If not chosen a serial number will be engraved together with our logo.
- * Different combination of coverings or different sizes are not previewed in our system. Special requests, if possible, will be considered a "not standard product" and a 10% surcharge will be applied.

FOOTSTOOLS & TABLES





FOOTSTOOLS
& TABLES

_Bentley



_Corniche



_Incas



_Monaco/Zen



_Pompei



_Victoria



_Tender side



_Palatino



_Tender centrale



ELEMENTS	H	L	D	V	W
BENTLEY FOOTSTOOL	40	60	60	0,14	10
CORNICHE FOOTSTOOL	40	60	60	0,14	10
INCAS FOOTSTOOL	40	60	60	0,10	12
MONACO FOOTSTOOL	41	64	64	0,15	10
ZEN FOOTSTOOL	41	64	64	0,15	10
PALATINO FOOTSTOOL	45	58	58	0,45	13,5
POMPEI FOOTSTOOL	48	56	56	0,15	11,5
VICTORIA FOOTSTOOL	44	54	54	0,20	12
TENDER SIDE TABLE	43	50	50	0,10	20
TENDER TABLE	32	90	90	0,30	27

* Different combination of coverings or different sizes are not previewed in our system. Special requests will be considered a "non standard product" and a 10% surcharge will be applied.

DECORS



DECORS



Cushion Decor K501



ELEMENTS

	L	D	V	W
LEONARDO PILLOW 45X45	45	45	0,05	2,00
LEONARDO PILLOW 50X50	50	50	1,50	2,00
LEONARDO PILLOW 50X70	50	70	0,05	2,00
LEONARDO PILLOW 55X55	55	55	0,05	2,00
LEONARDO PILLOW 65X65	65	65	0,06	2,00
LEONARDO PILLOW 75X50	75	55	0,07	2,00
LEONARDO PILLOW 80X50	80	50	0,08	2,20
LEONARDO PILLOW 80X65	80	65	0,09	2,60
CUSHION DECOR 50X60			0,01	2,00
CUSHION DECOR 62X62			0,05	2,50
CUSHION DECOR 50X50			0,06	4,00
HELP CUSHION			0,08	0,80
CUSHION DECOR 40X40			0,04	1,50
CUSHION DECOR 45X45			0,50	4,00
CUSHION DECOR K 501			0,06	4,00

* Different combination of coverings or different sizes are not previewed in our system. Special requests will be considered a "non standard product" and a 10% surcharge will be applied.

* All decor cushions are always put inside the packed sofa, they don't come alone.

GENERAL SALES CONDITIONS AND TECHNICAL SPECIFICATIONS

The pictograms, weights, volumes and dimensions of the products indicated in the catalogue are purely indicative. The colours and sizes listed may not faithfully reproduce the real ones and cannot be the subject of any complaint.

An extra charge of 10% may be applied for not standard production.

Excluding exceptionally busy periods or holidays breaks the average delivery term for our STANDARD products varies from eight to ten weeks. For NON STANDARD products or special production the delivery time may be increased of 2-4 weeks. The exact time will be stated in our written confirmation. Please always carefully check it and timely report unclear issues.

Roma Imperiale has the right to make changes without notice. The information contained in this publication are not binding. Some product might go out of production from one publication to the other so please always ask for products' availability.



PRODUCT INFORMATION

- The structure is made of solid poplar or beech wood.
- The product is assembled using glue and interlocking joints.
- All our materials comply with European standards.
- The seat support is sustained by elastic belts.
- The filling and Dacron are CFC-free.
- The leather upholstery is PCP-free.
- The packaging is recyclable.
- The bed function changes the design of the sofa. Bed nets can be 2 folds or 3 folds according to the chosen model.
- The electrical recliners works with a 220 voltage. For lower voltages please ask for the special adaptor.
- Mechanical headrests can be put in any of its inclined position by gently lifting up the cushions with both hands, and can be closed back by pushing the mechanism till the end until it softens and then put it back in the original position.
- Do not move the sofa by pulling it or pushing it from the headrests or armrests with mechanism as they can be damaged.

LIGHT PADDING FURNITURE PRODUCTS

Upholstered furniture with international flair and style mainly has "light padding". It expresses casual elegance and comfortable, cosy seating. When new this upholstery appears relatively smooth, in use it becomes soft and snug and most enjoyable. Most of the Nieri upholstered furniture are manufactured according to modern criteria with "light padding". If you have chosen cushions of a down feather-type or with a Dacron soft inlay we would like to remind you that the content of the cushions is distributed equally into individual chambers. The formation of waves and hollows in usage is not a sign of low quality but of its natural and genuine materials and expert crafting.

According to the intensity of use especially in the area of the "favourite seating place", regular shaking or plumping may be necessary. Claims for such a natural feature such as "light padding" will not be accepted.

WARNING! ACHTUNG! ATTENTION!

JOINTS FOR CORNER ELEMENT ARE INSIDE THE PACKAGING OR THE SOFA OR ARE ATTACHED TO THE SIDE. IN ORDER TO JOIN ELEMENTS JUST LIFT UP THE ELEMENT WITH THE MALE JOINTS AND INSERT THEM INTO THE FEMALE JOINTS.



MAINTANANCE INSTRUCTIONS FOR CLEANING AND CARE

Leather furniture might be compared with the car of your body. How you use and take care of your upholstered furniture is therefore essential for its appearance and life expectancy. Experience shows that the lighter and more natural the type of cover material the more sensitive it is to outer influences.

Please observe at all time the following care instructions:

- Never treat leather with solvents of any kind (e.g. turpentine, stain remover, cleaning paraffin, shoe polish, floor polish or any type of detergent). Please follow our recommended instructions as otherwise any claims under guarantee may become invalid.
- Any kind of stain must be removed immediately and in the proper way. Pay attention not to use in an improper way any cloths, detergents, chemical or mechanical products that could cause irreparable damages. It's important to distinguish the type of stain:

- OILY stains (e.g. oil, chocolate, mayonnaise): use blotting-paper to absorb and remove the oil substance from the surface. Clean with a damp cloth, not abrasive, soaked in water and neutral soap and then dry gently with another clean cloth.
- SOLUBLE stain (e.g. Coffee, tea, milk): use a clean cloth, not abrasive, soaked in water and neutral soap. Remove the soluble substance and dry with another clean cloth.
- DRY stains: first of all don't rub the dirty part. Take a soft brush and brush very gently.



For any other specific questions in the field of leather cleaning and leather care please contact directly our partner:

UNITERS S.p.A. _ Leather Masters

Via E. De Nicola, 1 36075 Montecchio Maggiore (VI) Italy

Phone number: +39 444 499099 Fax Number: +39 444 499106

Informazioni generali: info@uniters.com

LCK Leather Care Keller GmbH

Im Unterfeld 2, D-76698 Ubstadt-Weiher, Germany

Phone: (49) 7251 9625 0 • Fax: (49) 7251 9625 29 • E-mail: info@lck-international.com - www.lederpflege.de

NOVABUK FURNITURE AND FABRIC FURNITURE

Novabuk is a special new material made in part of leather and in part of microfiber, which gives it more resistance, is water and fire repellent and it's very easy to clean but it still keeps the soft touch of Nabuk.

Novabuk furniture can be cleaned with simple water by just rubbing the stained part gently with a smooth cloth, or by using special products suited for fabrics containing non aggressive agents.

Do not use alcohol or any other solvent for either Novabuk or other fabrics of our collection.

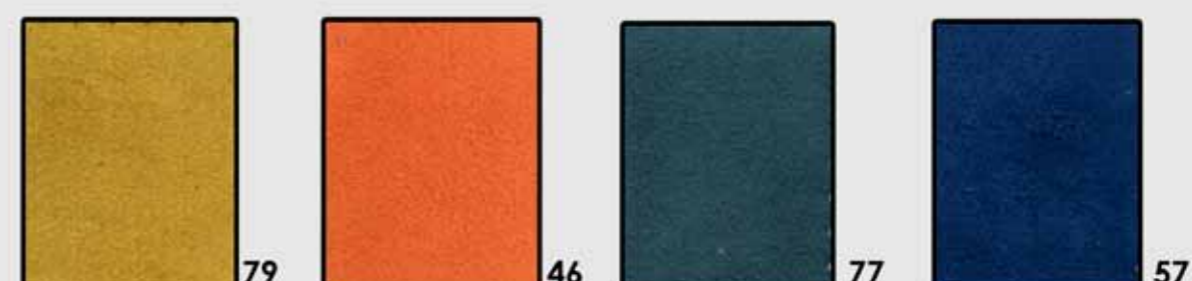
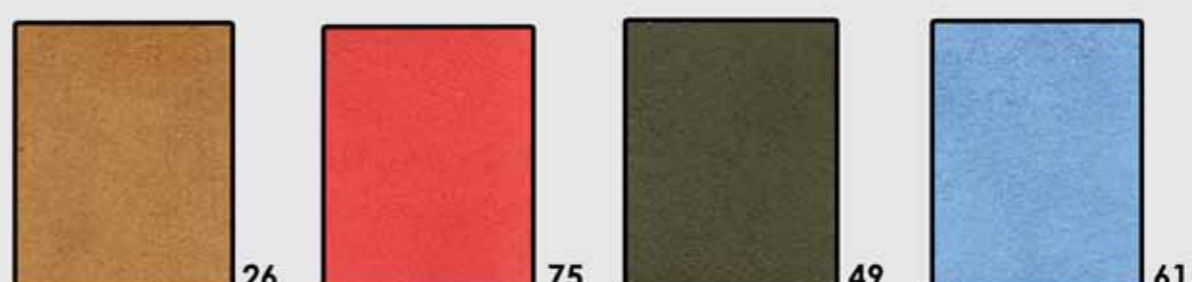
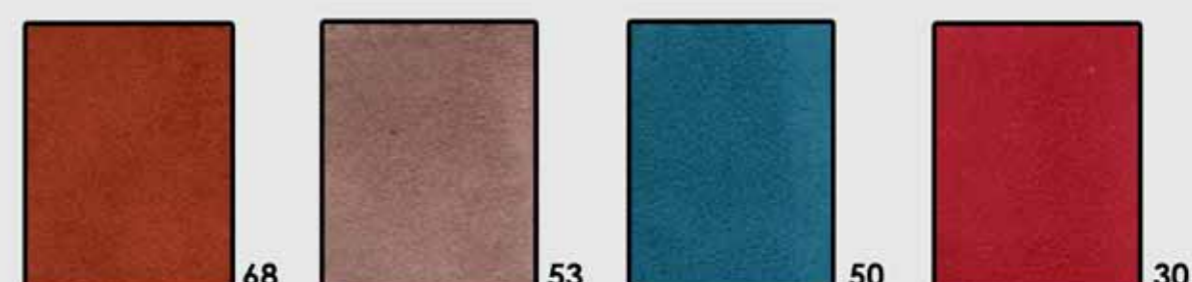
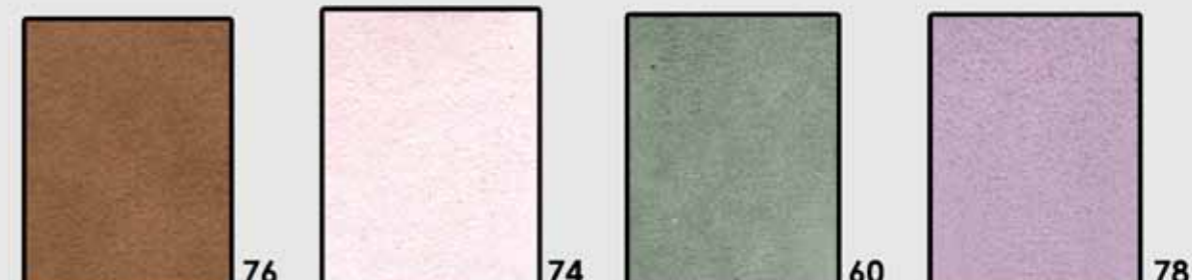
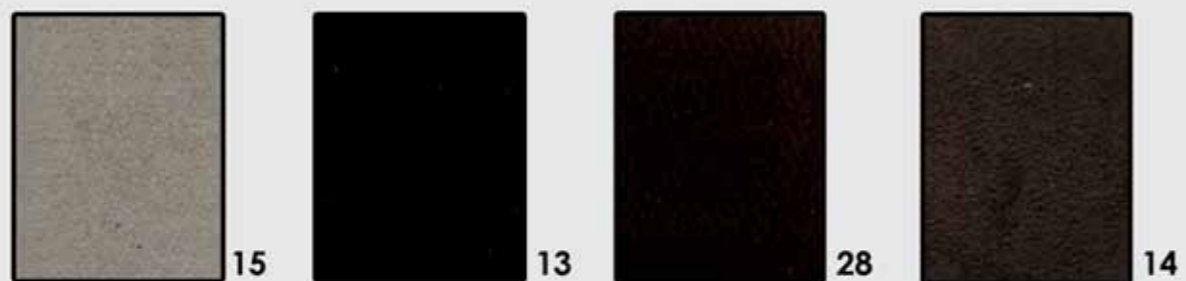
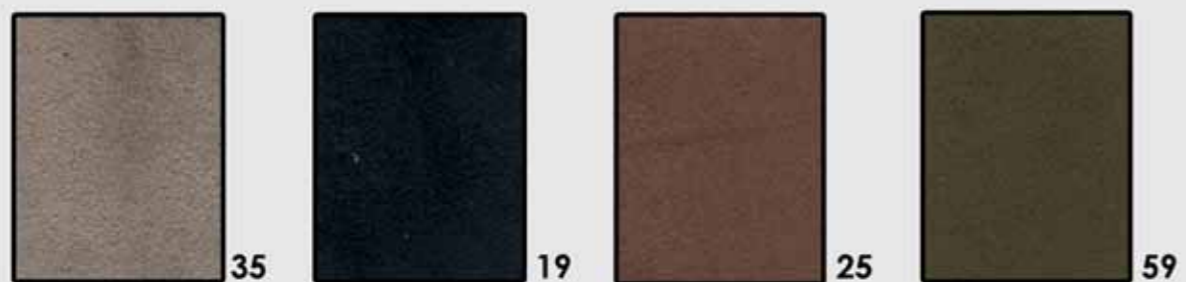
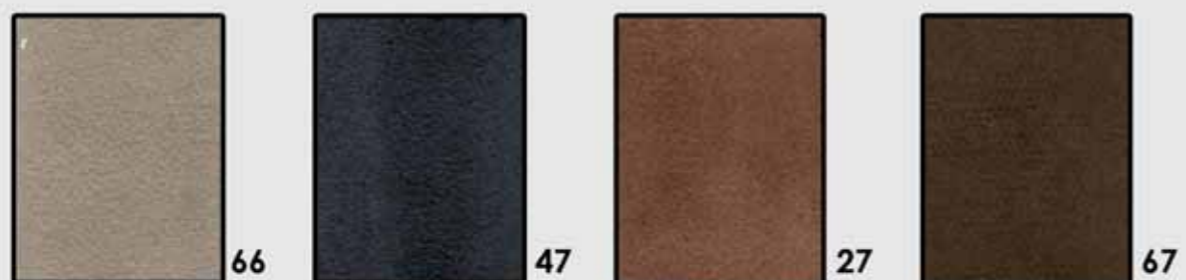

PLEASE NOTE: real colors of leathers or fabrics can be different from printed ones or from those displayed on screens.

NIERILUX



MUN CERTIFICATION OF 100% MADE IN ITALY _ NATIONAL MANUFACTURING

Our Company and brand Nieri exists in the Tuscan Territory, and more precisely in Quarrata since 1929.

We are proud to be one of the few Furniture companies to have our operating seat in the same Italian town when it all started, and to keep doing our job with the same values, the same craftsmanship, the same art and love of the same people who were here since the beginning.

This is a Family business, we believe in our country and in our territory, and we want to keep our quality, our standards and our products at a high level without having to displace our production or give up our traditions and quality standards.

That is why we decided to certificate our factory and brand with the MUN_Marchio Unico Nazionale, The National Manufacturing Certificate granted from Lloyd Register, an international Authority which, thanks to its procedures, can guarantee that all processes of our production, our materials, our manpower are actually 100% Made in Italy (actually Made in Tuscany in our case).

For more information please check the web site www.marchiouniconazionale.it

CERTIFICATE OF AUTHENTICITY

Roma Imperiale srl warrants that the products in this catalogues are authentic Nieri products. Nieri relies on first-rate, exclusive materials as well as on specialists' several years' expertise, so that the product can look like a one-of-a-kind object.

100% MADE IN ITALY

A unique blend of tradition and technology is what sets Nieri apart in terms of production. Nieri's products are craft-finished, while making the most of everything that is offered by industry, with a view to achieving the highest tailoring standard, strictly and genuinely Italian made. This is made possible by the company's long craft history, through highly professional dealers' proven skills and expertise as matched with the state-of-the-art working machines, which result in high-precision, mechanised cutting, whereas trained artisans are the name for remarkable sensitivity and unparalleled expertise in refining details, approaching sofas as finely tailored products. Expert hands producing quality, hands guided by passion and creativity, skilled, conscientious hands. Hands respectful of tradition and capable of controlling technology. Hands proud of developing ITALIAN MADE products.

TEXTILE AND LEATHER COLLECTION

The textile collection is one of Nieri's main pluses, much emphasis being placed on it and major resources being devoted to it. A new fabric and leather collection is developed every year, based on sophisticated textures and first-rate yarns, charming glossy/matt effects and structured wefts, specially designed by the company and exclusively manufactured for Nieri, to cater to the personal taste of anyone who is not fond of the idea of mass production. A unique collection which magnifies the high quality standard and creates a competitive edge for the seating systems. From cotton to velvet, from linen to chenille, from Nubuk to leather: Nieri's covers are the ultimate synthesis of comfort and versatility, lightness and durability, luxury and fashion. Many types of fabric capable of enhancing fine details and resulting in different characters and personalities for the products, according to one's own taste and lifestyle. Nieri's leather emphasizes the outstanding quality of both the products and the tailoring details, thus providing a unique plus. Leather means tradition, emotion and dexterity: investing in surveys and research has allowed Nieri to make customized colours, finishes and tanning available, with a view to developing products catering to the most sophisticated needs. The quality of Nieri's fabrics and leather is guaranteed by several strict, purpose-designed tests, in accordance with the most stringent European standards



CERTIFICATE OF WARRANTY

Regardless of, and in addition to, law provisions concerning product warranties, Roma Imperiale srl warrants the frames of its upholstered products (sofas, armchairs, chairs and sofas) for 10 years (from date of invoice). The leather and fabric covers, upholstery, mechanisms, accessories and component parts are covered by 24 months warranty. The warranty period for the occasional tables, is 2 years. The warranty covers original manufacturing defects of the product and includes free replacement or repair of such damaged or defective parts as acknowledged by Nieri or any representative designated by Nieri.

The warranty does not cover any damage caused by normal wear, mistreatment or misuse, accidental breakage or acts of God, nor does the warranty cover any defects other than those attributable to Roma Imperiale srl, including improper assembly or any assembly that does not comply with the mounting instructions. The warranty will not be applicable if the products are dismantled, modified or repaired by any third parties that are not authorized by Roma Imperiale srl. The warranty does not include fabrics and leather supplied by the Customer.

Leather is a natural product which keeps a few properties – even when worked – which define its origin, without affecting durability and quality: insect bites, small healed wounds, marks, wrinkles, differences in “grain” should be considered to be characteristics, and not defects. The natural adjustment of the upholstery is not a defect either. Wood is a “live” material: any small movements as temperature and humidity change are absolutely natural, and should be considered to be typical of furniture. Any warranty jobs will not cause the warranty to cease to be applicable. The warranty will cease to be valid after 10 years of the date of invoice. To exercise the rights arising from the warranty, this “Certificate of Warranty” and the purchase invoice shall be shown to Roma Imperiale srl and be kept throughout the period of validity of the warranty.



PACKAGING

Our packaging is designed to face each and every kind of shipping, weather conditions and kind of transport. As we do know that our products are delicate and valuable, that leather and wood are sensible to changes of temperature and to continuous pulling forces we provide a multilevel packaging.

1. The first layer is either cardboard or foam for the most sensitive part of the sofa and according to the model.
2. Secondly the whole sofa or piece of sofa is enveloped in a layer of nylon as to protect it from dust.
3. The third layer is a special plastic material called FOAMM which is flexible but more resistant than simple plastic layers, which is to protect the sofas from scratches or internal damages if the sofa is shacked or pulled along a wall.
4. Finally an airball envelop with our logos and our labels is wrapped around the whole pack and tied with strings and adhesive tape.

In this way we ship all over the world by ship, airplane, trucks and all our products come undamaged to their final destination for happy customers.

You can see a part of the production system and packaging at: <http://www.romaimperiale.net/made-in-Italy>

DIVANO CON MECCANISMO
CARICARE IN POSIZIONE ORIZZONTALE SUI PROPRI PIEDI,
NON IN VERTICALE SUI BRACCIOLI.

DO NOT LOAD UPSIDE-DOWN OR ON THE SIDES
 NE PAS CHARGER SUR LE DOSSIER NI SUR LES ACCOUDOIRS
 WARE DARF NUR WAAGERECHT VERLADEN WERDEN

ATTENZIONE – FRAGILE!!!!
 CONTIENE ACCESSORI E MECCANISMI DELICATI
 NON SOVRACCARICARE

ATTENTION – FRAGILE !!!
 IL CONTIENT ACCESSOIRES ET MECCANISMES DELICATS
 NE PAS SURCHARGER

VORSICHT – ZERBRECHLICH !!!!
 Enthält mechanische teile
 VOR NÄSSE UND DRUCK SCHÜTZEN



CONTACTS

Tradition is Handmade,
Handmade means Nieri.



fatto a mano

For any question, quotation or information about our products and company you can contact the following references:

 Information in English	info.en@romaimperiale.net
 Informationen auf Deutsch	info.de@romaimperiale.net
 Renseignements en Français	info.fr@romaimperiale.net
 Información en Español	info.es@romaimperiale.net
 информация на русском языке	info.ru@romaimperiale.net

For more information please check also our web sites:

www.romaimperiale.net - www.nieri.it - www.niericountry.it
www.nierifrance.fr - www.nieridivani.it

CREDITS :

PH: Ambra Vaglini

GRAPHIC DESIGN: Ambra Vaglini

PRINTING: Toccafondi 1910

Luglio 2016

NIERI is a trademark of ROMA IMPERIALE srl

Via Bologna, 13 - 51039 - Quarrata - PT- ITALY
tel: 0039 0573 7733 - fax: 0039 0573 739710



CERTIFIED COMPANY MUN
NATIONAL MANUFACTURING
ITCOT.MUN-A000016